

# PARKLET95: INTEGRAÇÃO CORPO-ESPAÇO-CIDADE

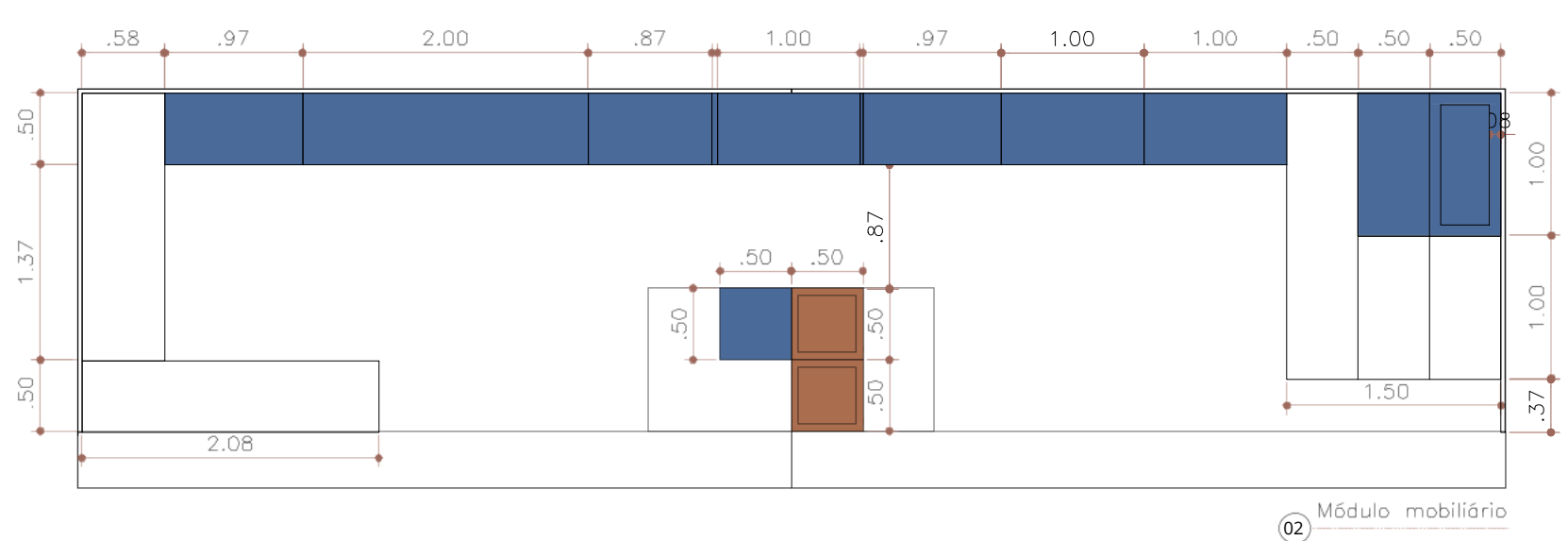

concurso de mobiliário urbano para a primeira infância de Salvador

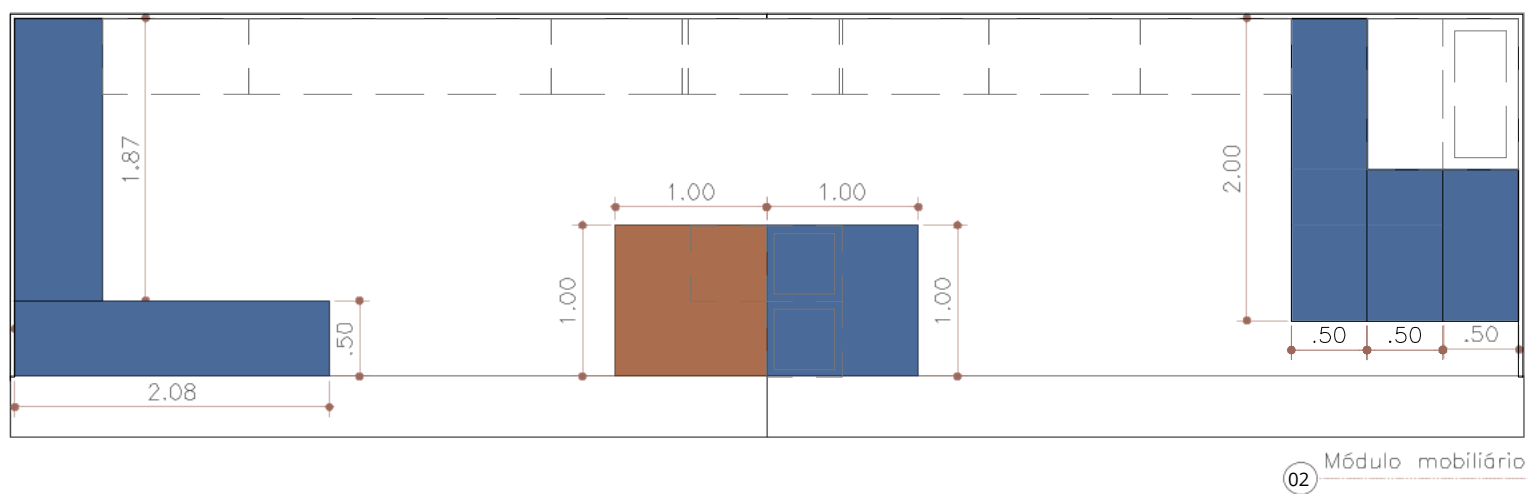
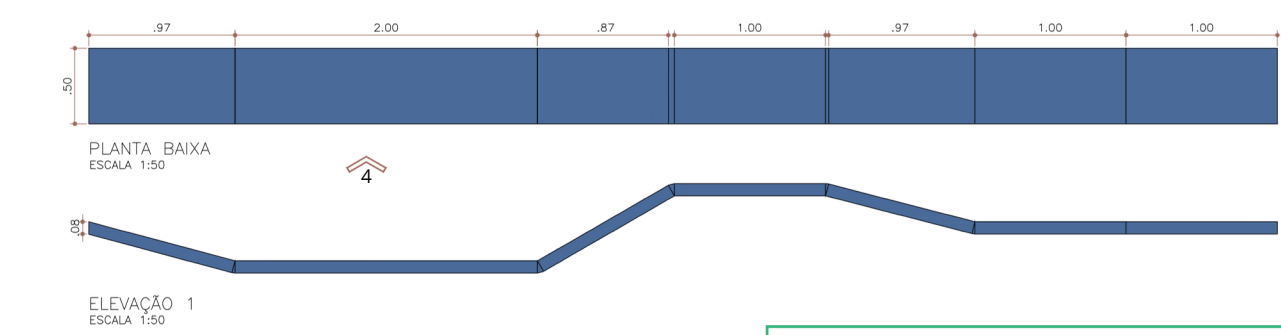
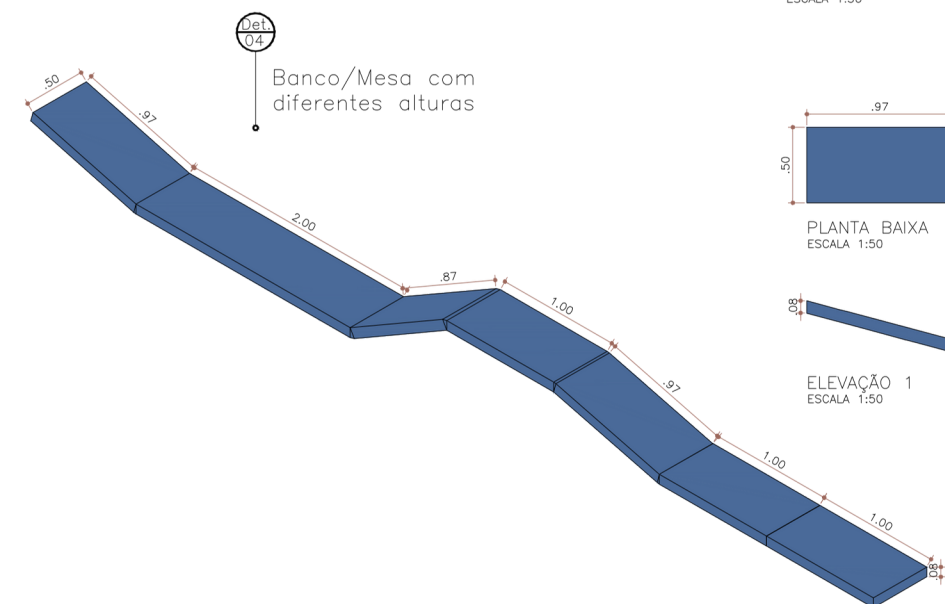
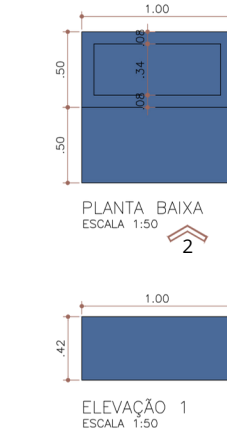
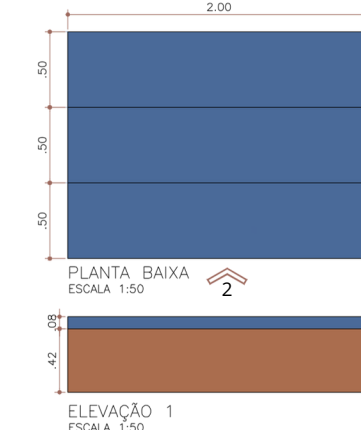
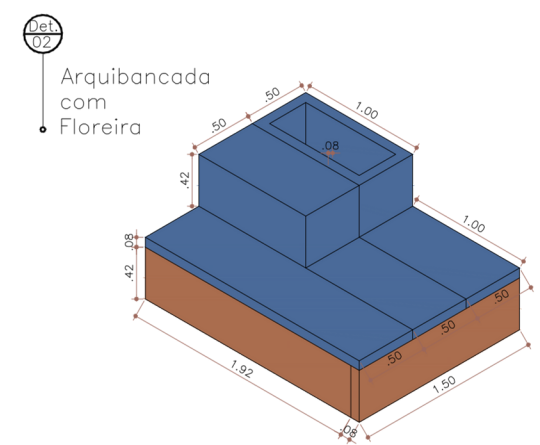
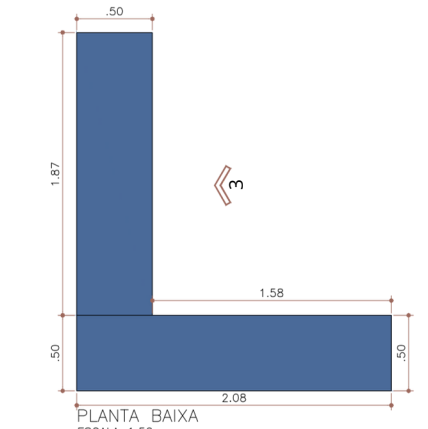
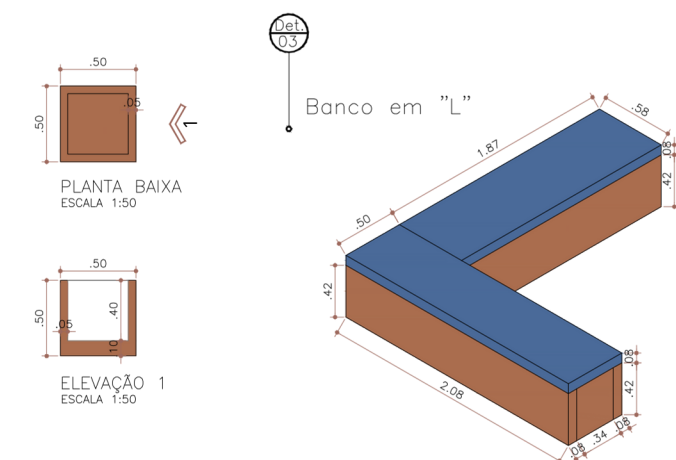
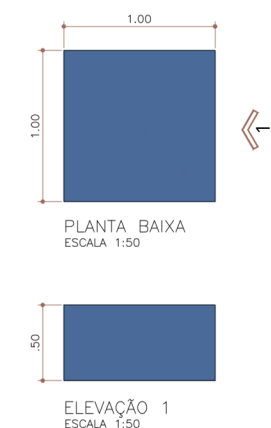
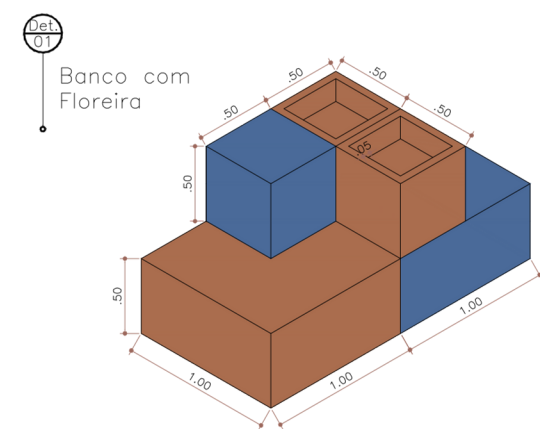
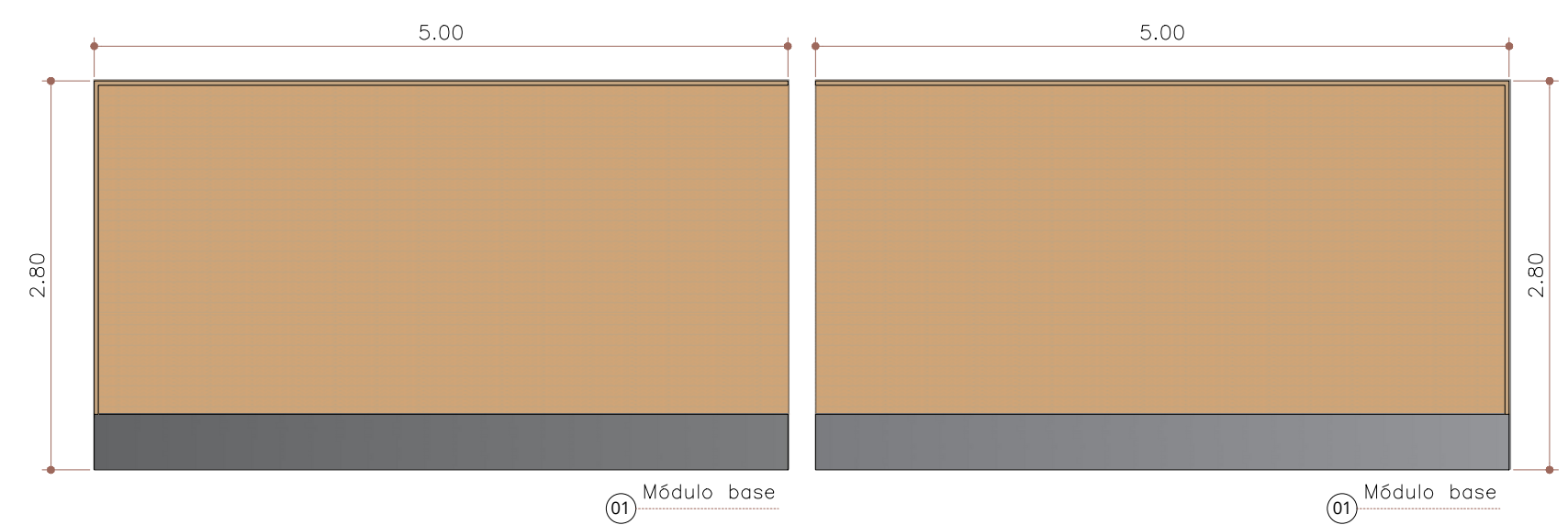
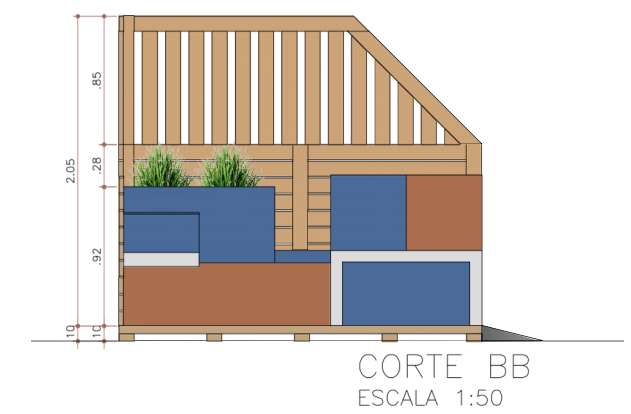
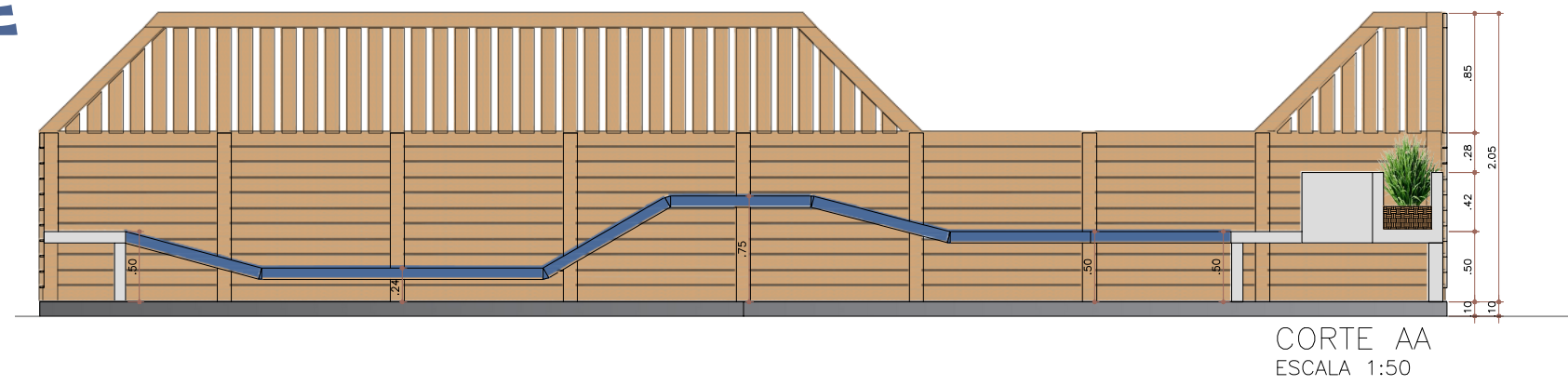
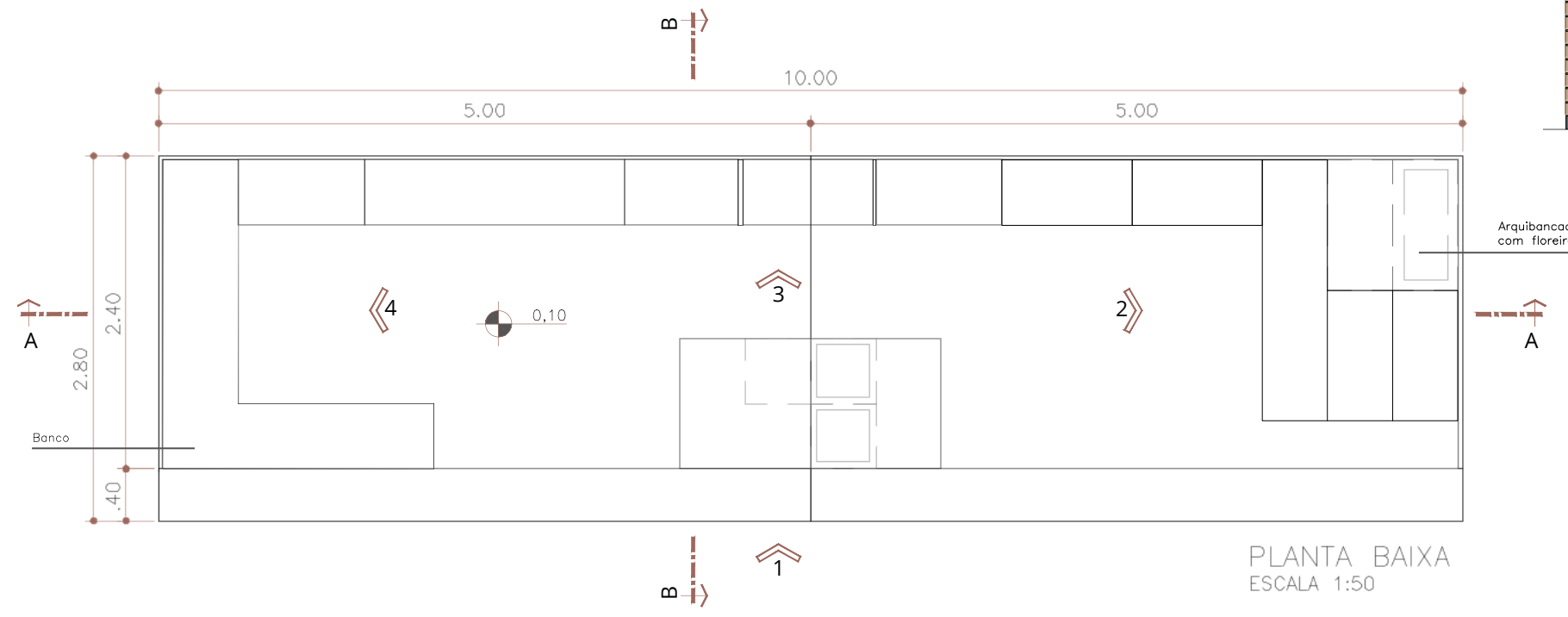