

PAÍNEL INFORMATIVO EM ESTRUTURA METÁLICA COM TUBOS DE 2 x 2 CM E PINTURA ELETROSTÁTICA IMITANDO MADEIRA. É FIXADA NA ESTRUTURA UMA CHAPA DE EUCALIPTO DE 41 x 71 CM A QUAL RECEBE A ARTE GRÁFICA INFORMATIVA EM MATERIAL RESISTENTE A INTERPÉRIES (EX CHAPA PVC).

ÁBACO EM TUBOS METÁLICOS DE 1 CM DE DIÂMETRO COM PEÇAS DE EUCALIPTO PINTADAS NA COR DO VEGETAL CORRESPONDENTE E CENTRO VAZADO EM 1,5 CM).

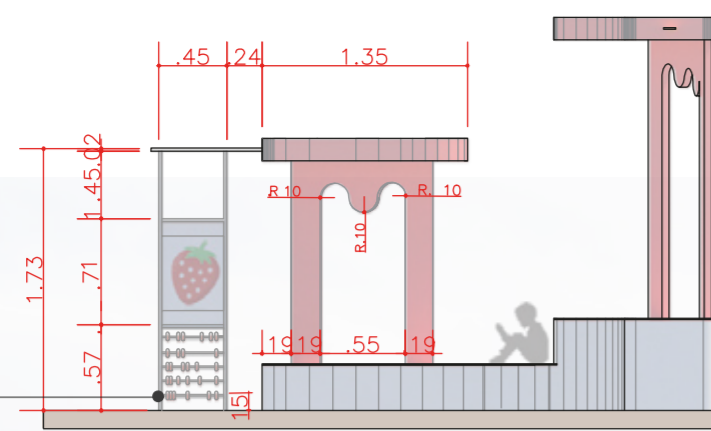

VISTA A
ESC.: 1:50

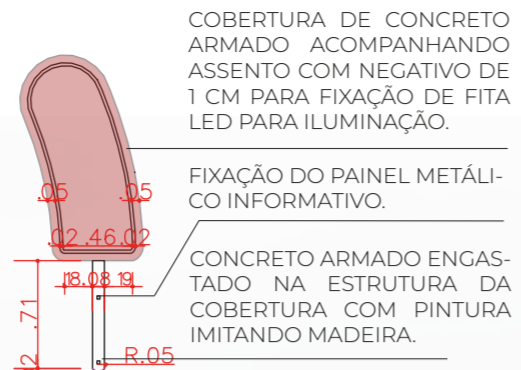

DET. C - COBERTURA
ESC.: 1:50

VISTA B
ESC.: 1:50

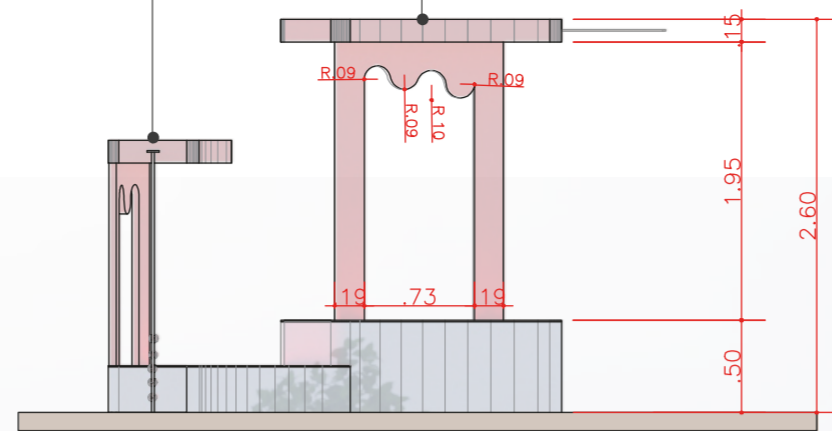

DET. D - COBERTURA
ESC.: 1:50

VISTA C
ESC.: 1:50

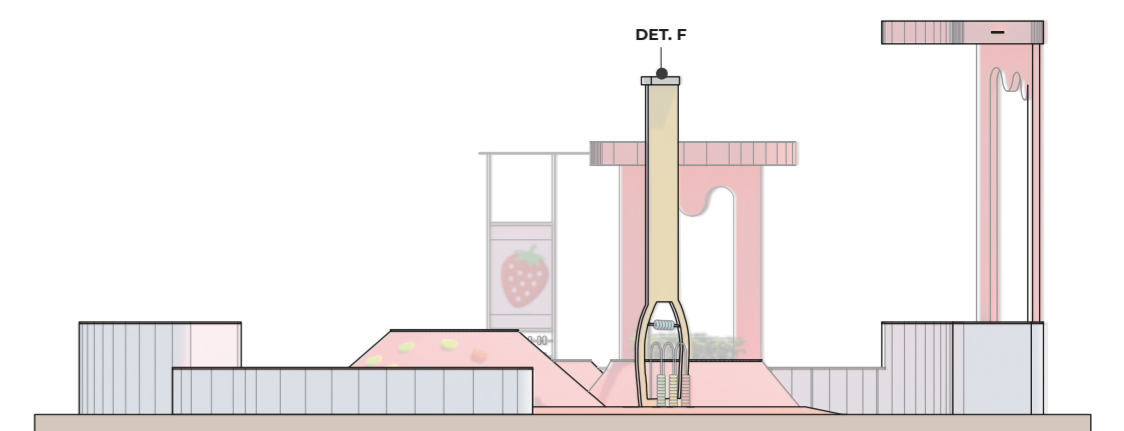

ASSENTO DE EUCALIPTO INVERNIZADO E PINTADO

BANCO DE CONCRETO PINTADO
ESPERAS CAVADAS
GANCHOS DE ANCORAGEM

DET. E - ASSENTO
ESC.: 1:50

DET. F - POSTE BALIZADOR E ÁBACO:

LUMINÁRIA EM METAL COM PINTURA ELETROSTÁTICA IMITANDO MADEIRA, ILUMINAÇÃO DE LED, ACENDIMENTO AUTOMÁTICO, FIXAÇÃO COM CHAPA E PINOS METÁLICOS.

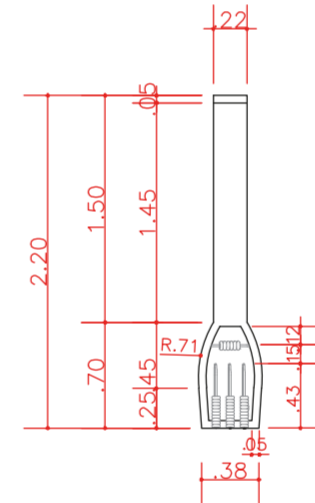
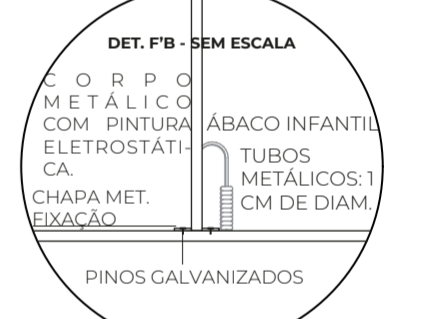
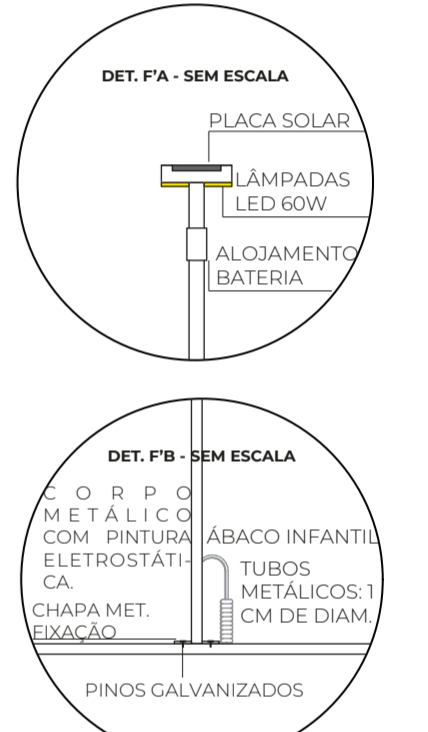

VISTA FRONTAL
ESC.: 1:50



VISTA POST.
ESC.: 1:50

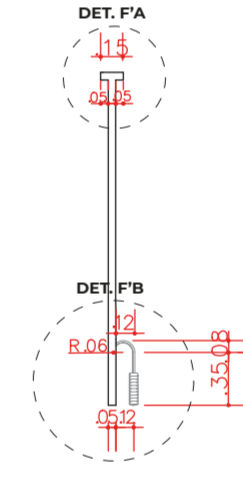

VISTA LAT.
ESC.: 1:50



concurso de mobiliário urbano para a primeira infância de Salvador

